

ПРИЛОЖЕНИЕ №1

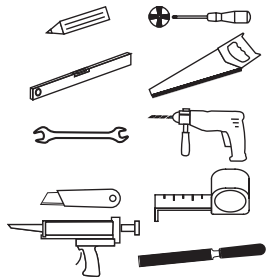
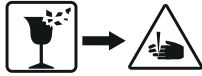

**RU** ИНСТРУКЦИЯ ПО МОНТАЖУ И ЭКСПЛУАТАЦИИ

**EN** INSTALLATION AND OPERATION MANUAL

**KZ** МОНТАЖ АҢАҢЕ ЕКСПЛУАТАЦИЯ БОЙЫНСА АНУСАҒА ЛЫҚ

**AZ** QURADIRMA VƏ İSTİSMAR TƏLİMATI

**UZ** ЙИГИШ ВА ФЙДАЛАНИШ БУЙИЧА ЙУРИҚНОМА

**GE** მონტაჟის და ექსპლუატაციის ინსტრუქცია

**AM** ՄՈՆՏԱՅԻ և ԵՃՆԱԳՈՐԾՄԱՆ ՀՐԱՀԱՆԳ

**TJ** ДАСТУРАМАЛ ОИДИ НАСБКУНИ ВА ИСТИФОДАБАРИ

**KG** МОНТАЖДОО ЖАНА ЭКСПЛУАТАЦИЯЛОО БОЮНЧА НУСКАМА

**1**

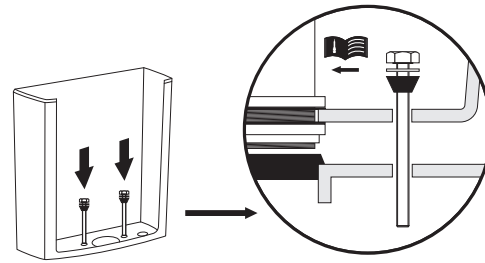

**3**

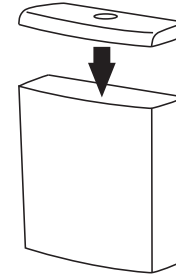

**2**

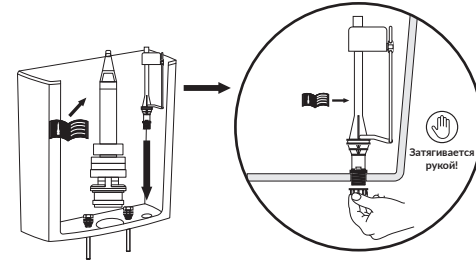

**4**

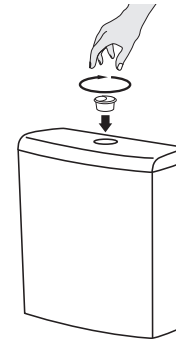

**5**



**6**

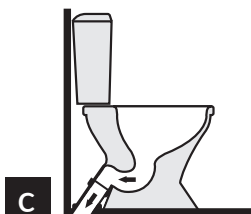
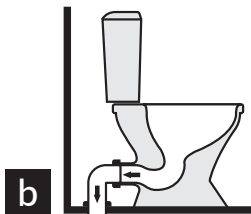
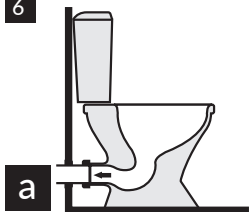

**7**

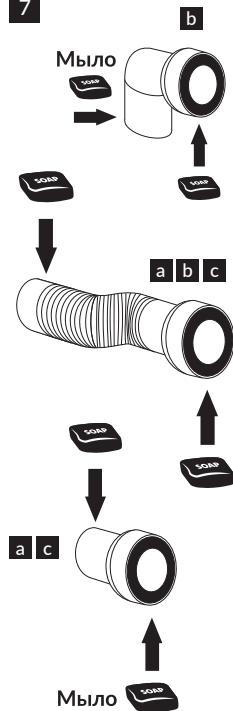

**8 a**



**8 b**

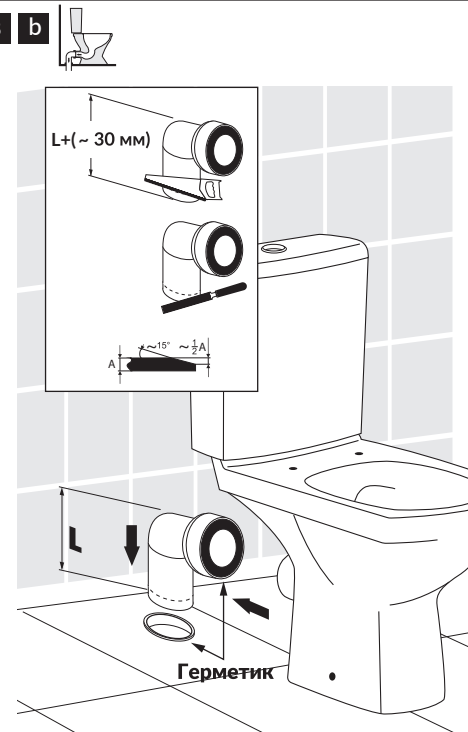

**8 c**



9 a

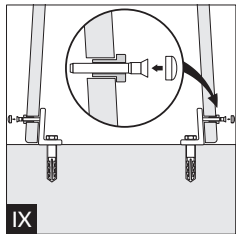
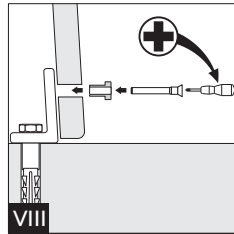
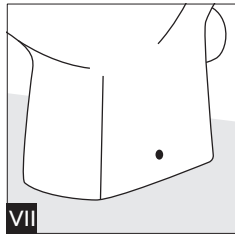
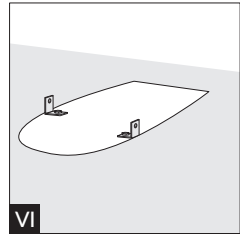
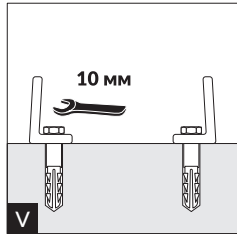
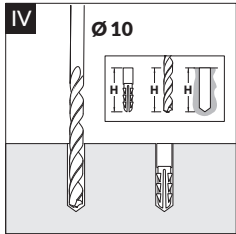
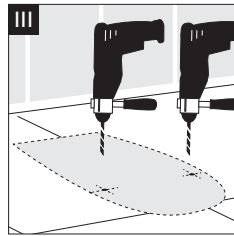
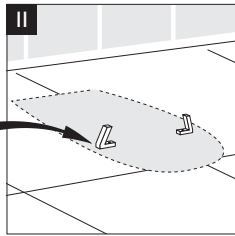
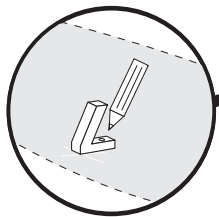
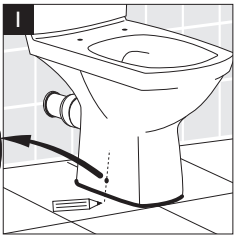
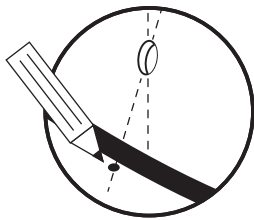

9 b

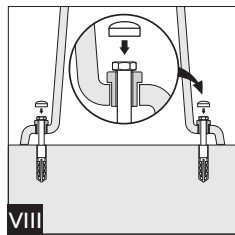
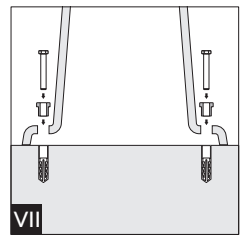
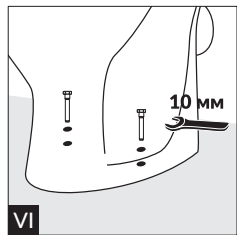
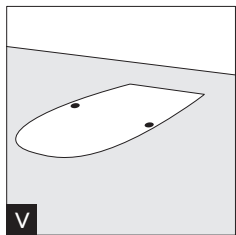
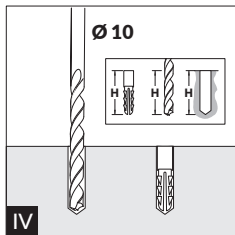
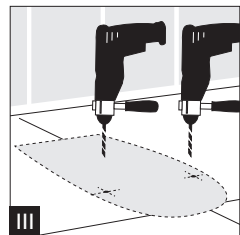
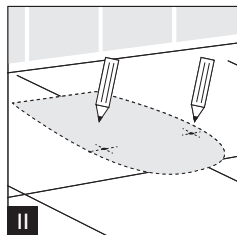

10



11

